



SAME CO., LTD.

SPECIALIZED MANUFACTURE DESIGN



The specialized heart · environmental protection sentiment ~
is the same management idea.

■ Slanting Pipes



■ Honeycombed Contact Filter by PVC & ABS



■ Waved Crisscross Contact Filter by PVC & ABS



■ Network Shape Filter

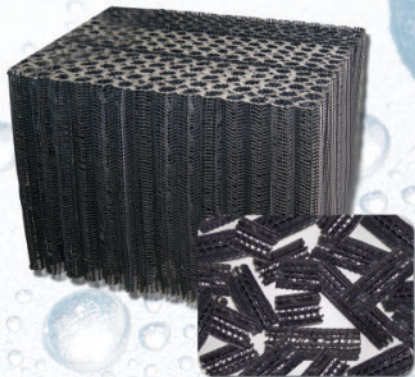

■ Sewage Well



■ Kitchen Sewage Piping Box



■ Rotating Biological Contactor (RBC)

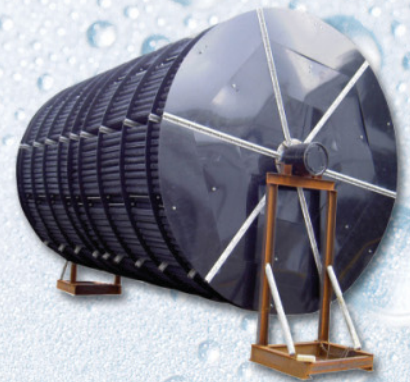

★ CONSISTENT PRODUCTION WORK

★ FACTORY STRAIGHT CAMP PRICE POSITION

★ EXCELLENT IN QUALITY GUARANTEE

★ AS SCHEDULED DELIVERS CONFIDENCE

SAME CO., LTD.

No.485, LANE 506, SEC.1, HIS NAN RD., TONG YANG VILLAGE,
WU JIH HSIANG, TAICHUNG HSIEN, TAIWAN

TEL:04-23352827 FAX:04-23352659

<http://www.similar.com.tw> e-mail:same66@ms16.hinet.net



SLANTING PIPES

FEATURES:

- For the slanting pipes the standing pipes of the single housing should be put in the precipitation pond to achieve its function. The housing of the slanting pipes is aimed to connect the slanting pipe at an angle of 60 degrees and from a reversed slanting arrangement of crisscross structure with the adjoining pipes . The shape of the housing becomes the standard of rectangle with a diameter of 50 mm.
- The "rectification" and "dual concrete effect" can truly catch the emulsion not easily precipitated . The quality of water can be said to be excellent in a variety of precipitating facilities subject to the treatment in the slanting pipes . The consumption of concrete agent can be saved.
- Although ABS structure at the thickness of 1mm is used. It should be strong and can bear a weight of over 500kg because of being a complex frame.
- The installation is easy. Just put it on the frame at the time of installation.
- There is only one layer of the slanting pipes. Structurally. There is no bending. So that it is very convenient.
- There is no barrier such as girdle different from the slanting board so that it is easy to look at the quality of water from the surface of the precipitate pond. The appearance is good.
- There is no barrier at the bottom of the pond so that you can freely choose direction for collection the mud, collecting mud machines, water mud excavating machines, and conveyance belts for installation. The space below the housing of the slanting pipes is wide and large so hat it is easy to check and maintain it.
- Precipitation is conducted within slanting pipes so that it is no subject to the external factors such as dense current. The slanting pipes are in the water so that there is no barrier.
- Horizontal precipitation pond figures, rectangular precipitation ponds, and precipitation ponds of any shape can be installed.



The Bottom of Pond

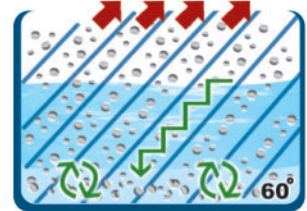

Slanting Pipes

standards→ Model ↓	Diameter of Pipes	A	B	I	W	H	L	Pipes sets	Thickness of boards	Materials
HCA-52	50	50	50	600	500	520	2500	10	0.6 / 0.8 / 1.0	ABS
HCA-75	50	50	50	860	500	750	2500	10	0.8 / 1.0	ABS

The specialized heart \ environmental protection sentiment ~ is the same management idea.



SAME CO., LTD.

NETWORK SHAPE FILTER

High performance of handing ammonia, nitric and other organic matters.

FEATURES:

- Made of HDPE high-density environmental protection
- From bio-membrane within a very short period with high efficiency
- High rate of removing organic substances, reducing the area occupied. Low investment costs.
- Great mechanical strength with the bending strength for over 8 tons per meter square
- Coarse surface makes organisms be easily attached.
- Network shape and permeability are effective high-potent bio-filter materials without blocking.
- Long life.
- Low maintenance fees.
- Arbitrary model (for example, floating, filtration, immersion) with arbitrary length.

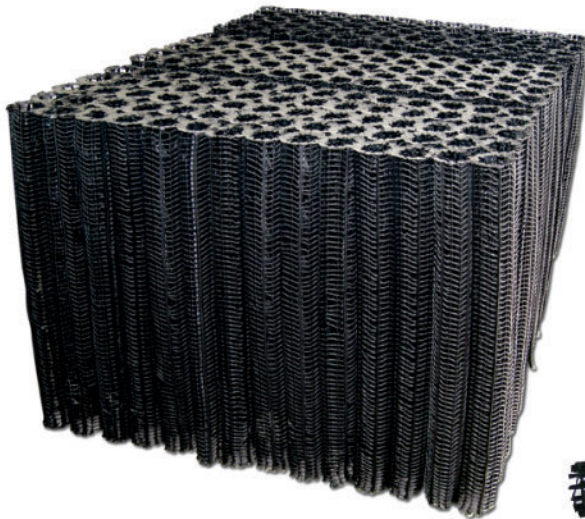

APPLICATIONS:

Water circulation system for aquaculture, industrial sewage, hospital sewage, daily living sewage and water tower filler.

Air pollution prevention: Absorb oil smoke of restaurant, absorb water smoke of cooling water tower.

Model	Effective surface area (m ² / m ³)	Flow rate (%)	Leaking rate (%)	Diameter of pipes (mm)	Unit amount
SAME-66	155m ² / m ³	95%	92%	66mm	1~3kg / D

The specialized heart · environmental protection sentiment ~ is the same management idea.



HONEYCOMBED CONTACT FILTER BY PVC & ABS

This contact filter is made with waved open shape of honeycombed structure. It possesses outstanding strength that can bear the lumpy surface and contain a wide and long contact surface with flowing fluid, make it turn to turbulence condition and then reach the highest oxidize rate. This is the epochal product that is the best choice for applying to organic disposal sewage treatment.

FEATURES:

- Larger surface with outstanding treatment function(45-105 m² / m³) .
- Remarkable strength and safe installation operation.
- Little water resistance, high leaking rate(99.0~99.3%), no obstruct produced on contact filter.
- Provided with moderate feature for bio-membrane to adhere to.
- High feature for capturing plankton
- Great mechanical strength, not easy to be out of shape, not easy to get curved, excellent durability.
- Low expense, high efficiency, great economic benefits.



- ⊖ Period of adsorption
- ⊗ Period of growth
- ⊕ Clastic reproducing
- ⊖ Stationary phase
- ⊖ Peel

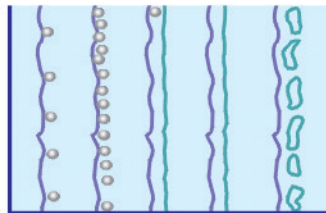

Specification Model	Aperture (mm)	Effective surface area (m ² / m ³)	Leaking rate (%)	Thickness of single slice	Standard dimension		
					L	W	H
CM-80	80	53	99.2	0.55	1000	500~	1000
CM-56	56	72	99.2	0.5	1000	500~	1000
CM-40	40	105	99.0	0.4~0.45	1000	500~	1000

The specialized heart · environmental protection sentiment ~ is the same management idea.





SAME CO., LTD.

WAVED CRISSCROSS CONTACT FILTER BY PVC & ABS

This contact filter is made with honeycombed crisscross structure. It is made of acid-proof and alkali-proof PVC material with foggy surface coating so that microbes are easy to be parasitic on.

FEATURES:

- Larger surface with high treatment function.
- PVC material used, great mechanical strength, can be installed with great safety. not easy to get broken or damaged, long consuming life.
- Wide space between filters, not easy to get blocked.
- Great water circulation rate.
- High function rate of catching plankton.
- The contact surface is designed with the functions for organisms to get cohered and to get flaked off.
- Easy to be installed, low price with good quality.



- ⌚ Period of adsorption
- 🕒 Period of growth
- 🌱 Clastic reproducing
- ⏸ Stationary phase
- 👉 Peel

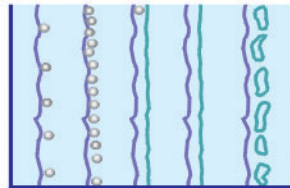

Specification Model	Dimension (mm)	Aperture (mm)	Leaking rate (%)	Material	Thickness (mm)	Effective surface area (m ² / m ³)	Strength (kg / m ²)
HCM-60	L x W x H 1200 x 600 x 600	58	98.7	PVC ABS	0.4~0.45	135	1500

USAGE OF OUR WAVED CRISSCROSS CONTACT FILTER

1.To be appalled to contact gas explosion system:

To immerse the filters in gas explosion pond with sufficient gas supply to produce sufficient circulation for the flowing disposal sewage to touch the filters, after a period of time, the organic mud(microbes) will grow and be attached to the surface of filters and turn to be bio-membrane. Then the bio-membrane will absorb and oxidized the organic matter.

2.To be applied to drop-filing system:

Prop the filing materials on the disposal sewage; use the circulation pump to drop down the disposal sewage has been dropping through the filing material for a period of time, there will be a colloid of bio-membrane on the surface of the filing material.

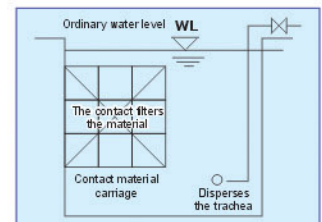

APPLICATIONS:

1. Sanitary sewer and daily sewage treatment.
2. Disposal sewage with large or small quantity
3. Third grade treatment.
4. Low density of disposal sewage treatment.
5. Treatment for disposal sewage with substance that is difficult to be decomposed.
6. To treat plankton that are not easy to get colloid coating or that have light colloid coating.
7. This treatment is good for resolving the difficult parts of disposal mud like water quality and quantity, and can reduce the mud quantity.

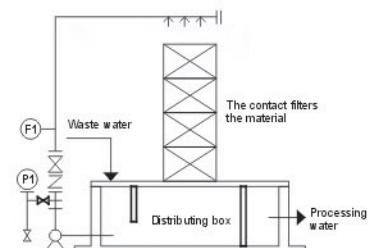

The specialized heart · environmental protection sentiment ~ is the same management idea.



SEWAGE WELL

FEATURES:

- Complex plastics are sued: great strength. Its resistance to pressure is tested to reach 39 tons by the Department of Civil Engineering of the National Chung Hsing University.
- The octagonal design has 4"Ø and 8"Ø bearings on all its sides So that the housing can vertically be connected to the water pipes on all of its sides and the connecting pipes do not need to bent or processed.
- The bearing of the connecting pipes are equipped with EPDM ejection-proof plastics for the sealing of well and to prevent the habitual use of pre-cast concrete well from easily leaking and polluting the environment. There is the set-up for shockproof set- up and minute displacement prevention.
- Materials are plastics and assembled so that they are light and easily transported and assembled. They are convenient and do not need any cranes. It is not subject to the restriction of narrow fireproof lane at the time of construction and can effectively save time and costs.
- The housing uses sus304 stainless steel screw with high durability.
- It is made of plastics so that the housing is not conductive.

APPLICATIONS:

Sewage line system, Hand of Telecommunications and Electricity.
Community sewage pipe connection: fastigium catchment well.

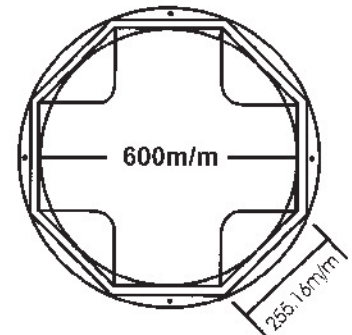
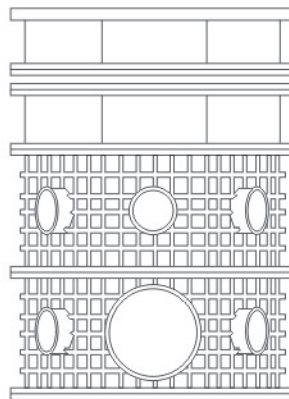
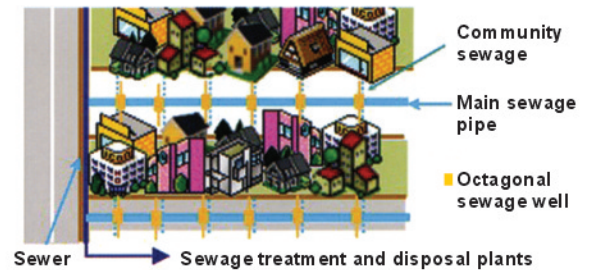

Cover of Frame	Adjustable layer	Adjustable layer	4"Ø	8"Ø	Base
150	150	20, 30, 50	300	300	55

SPECIFICATIONS:

Diameter 600m/m
(Assembled and height increased at your will)

The specialized heart environmental protection sentiment ~ is the same management idea.



SAME CO., LTD.



KITCHEN SEWAGE PIPING BOX

FEATURES:

- Complex plastics are sued: great strength. Its resistance to pressure is tested up to reach 12 tons.
- The design has 4" Ø and 8" Ø bearings on all its sides So that the housing can vertically be connected to the water pipes on all of its sides and the connecting pipes do not need to bent or processed.
- The bearing of the connecting pipes are equipped with water -proof rubber for the sealing of piping box and to prevent the habitual use of pre-cast concrete well from easily leaking and polluting the environment. There is the set-up for shockproof set-up and minute displacement prevention.
- Materials are plastics and assembled so that they are light and easily transported and assembled. They are convenient and do not need any cranes. It is not subject to the restriction of narrow fireproof lane at the time of construction and can effectively save time and costs.
- The housing uses sus304 stainless steel screw with high durability.
- It is made of plastics so that the housing is not conductive.

APPLICATIONS:

Sewage line system, Hand of Telecommunications and Electricity.
 - Community sewage pipe connection. fastigium catchment well.

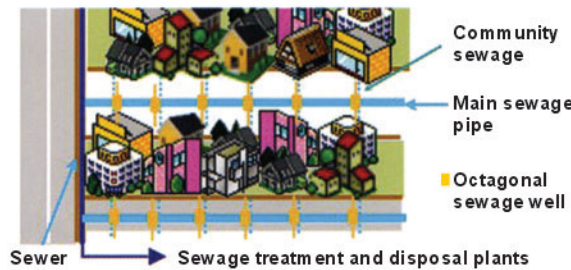
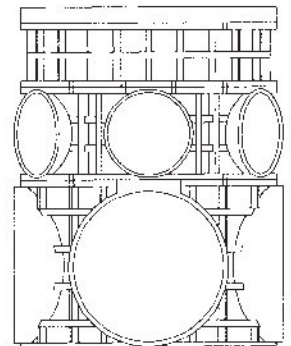

Multifunction connect hole

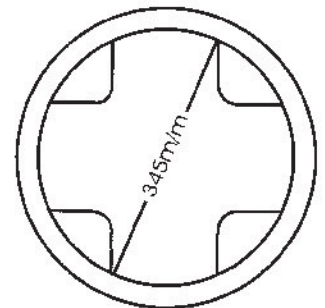

Ceiling layer	Ceiling layer	Ceiling layer	Ø100mm Six holes middle layer	Ø200mm Four holes base
25	100	300	150	255

SPECIFICATIONS:

Diameter 345m/m
 (Assembled and height increased at your will)

■ The specialized heart · environmental protection sentiment ~ is the same management idea.





ROTATING BIOLOGICAL CONTACTOR(RBC)

FEATURES:

- High flexibility: In general, the water feature and water quantity are complicated with big changes. Under this circumstance, the sewage treatment facilities should obtain high flexibility so to meet the current need and the future expansion and changes.
- Small measure of area: Among all kinds of treatments bio-membrane treatment takes the smallest measure of area.
- Low electricity consumption: Since the rotating contactor runs in low speed (2rpm), it takes very low electricity consumption. comparing with mud treatment, it takes only one-fifth of its electricity consumption or even lower.
- Easy to maintain. It requires very little maintain fee except lubricating the rotating shaft periodically.
- Easy to be operated. Ordinary workers with basic training can operate it smoothly.
- Great loading flexibility: It is superior to other traditional treatments in organic vibrating loading and in resisting the overflowing toxicant. It is because the short stay period for disposal sewage, so the overflowing toxicant that happens accidentally can be recovered very quickly.
- Small mud quantity with high concentration, no stinky smell either noise.
- High efficiency: Even with no initial facilities, it can remove 90% to 98% of BOD5.
- Fast to get reinstated: It takes only 3 to 5 days to get reinstated when operation starts or stops.

APPLICATIONS:

Bio-membrane treatment is a new technique for disposal sewage treatment. The technique includes water conservancy technique, bio-membrane circulation technique and microbe's segregation technique. It is most efficient and economic in dealing with residence and industry disposal sewage with high BOD nitride and carbide.



NAME / MODE	SAME-30
Surface square measurement	2350m ²
RBC housing	Network shape
Panel diameter	3000mm(size as per request)
Bio-membrane material	HDPE
Central shaft	Seamless stainless steel tube
Running speed	The main shaft rotates two times per minutes while the side speed is 18.85m per minute.
Motor	2HP
Retarding machine	Two sections of CYCLO or HELICAL
Bearing	Automatically change the bearing
Etch prevention treatment	The steel contains oxygen-encircled resin (except SUS304)

SPECIFICATIONS:

The rotating biological contactor (RBC) contains a serial of parallel network round shape filter that vertically joined. Half part of it is immersed in disposal sewage and half part of it is explored in air. The RBC interlock revolves around in water and in the air. Microbes that cultivated from organisms in water then adhere to RBC and form the bio-membrane. When the bio-membrane contact the disposal sewage it decomposes of digests the oxygen-fond microbes, and when it explodes in the air it continuously gains the oxygen, which required by oxygen-fond gem. With this rotating reflection the polluting condition and the oxygen-fond microbes will be reduced and reach to the discharge standard.

■ The specialized heart \ environmental protection sentiment ~ is the same management idea.